

Nordic S4

PRODUCT CODE 800130, 800131, 800132, 800133



Ventilation unit for small houses, single-family houses and small commercial buildings.

Product description

- Balanced ventilation with a good indoor climate
- Very energy-efficient with high efficiency and low SFP value
- Quiet
- Smart control with Flexit GO

Automatic control

The Flexit GO app is standard for the unit.

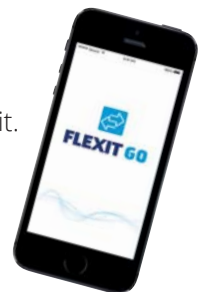

A CI 70 control panel can be ordered as an accessory.

	NOBB	GTIN	Model
800130	52944341	7023678001301	Nordic S4 RER right-hand model with electric battery
800131	52944356	7023678001318	Nordic S4 REL left-hand model with electric battery
800132	52944360	7023678001325	Nordic S4 R R right-hand model without electric battery
800133	52944375	7023678001332	Nordic S4 R L left-hand model without electric battery

Technical data

	S4 RE	S4 R
	with electric battery	without electric battery
Rated voltage (AC 50 Hz)	230 V	230 V
Frequency	50 Hz	50 Hz
Fuse size	10 A	10 A
Rated current	7 A	3.5 A
Rated power, total	1200 W	400 W
Rated power, max. electric battery	800 W	-
Rated power, fans	2x115 W	2x115 W
Rated power, rotor motor	4 W	4 W
Fan type	B-wheel	B-wheel
Fan motor control	0-10 V	0-10 V
Max. fan speed RPM	3,980	3,980
Automatic control, standard	Flexit GO	Flexit GO
Filter class	ePM1 55% (F7)	ePM1 55% (F7)
Filter type (supply air/extract air)	Compact filter	Compact filter
Filter dimensions (WxHxD)	247 x 365 x 31 mm	247 x 365 x 31 mm
Weight	62 kg	62 kg
Kitchen fan connection	Dia. 125 mm	Dia. 125 mm
Duct connection	Dia. 160 mm	Dia. 160 mm
Height	727 mm	727 mm
Width	753 mm	753 mm
Depth	610 mm	610 mm
Colour	White	White
RAL	9016	9016
Gloss	25-35	25-35

Energy class: 

CTRL 0.65

LOCAL DEMAND CONTROL

Sensor control for different zones
Accessories: App + CO₂ sensor/motion sensor + damper
Result: Increased air flow rate in zones that need it

Dimensioned drawings

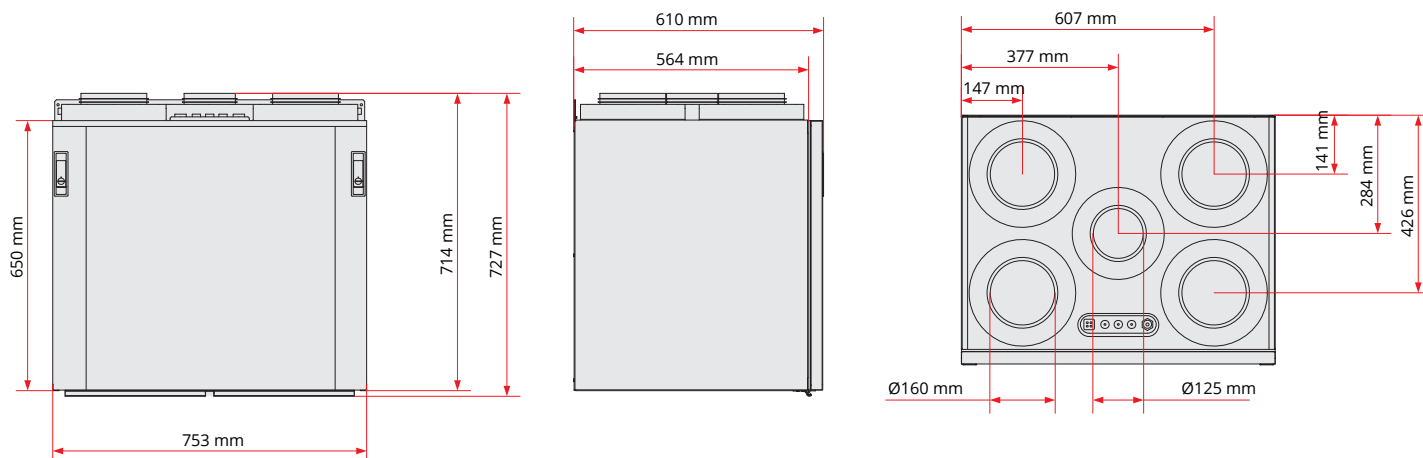

Capacity diagram

Supply air side

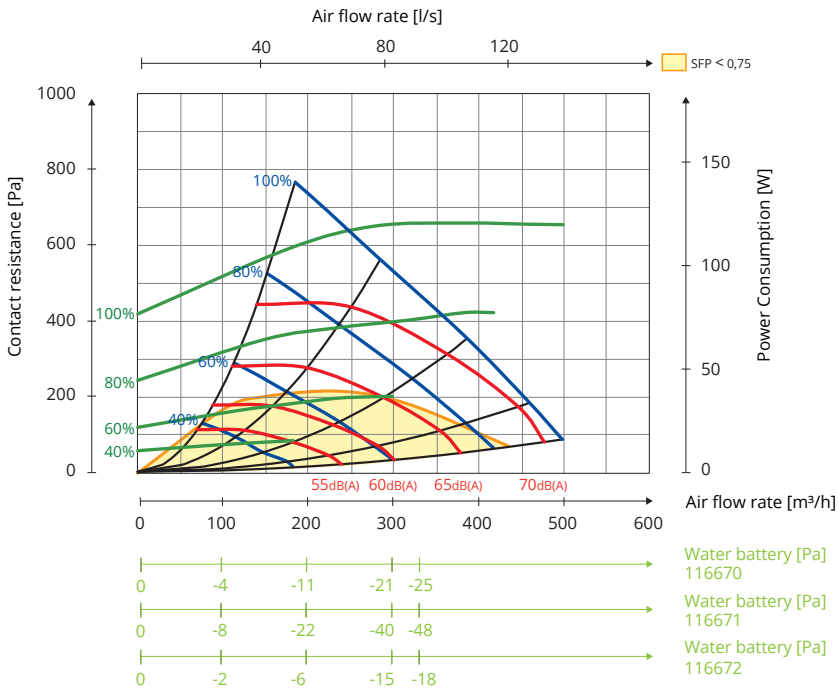

Extract air side

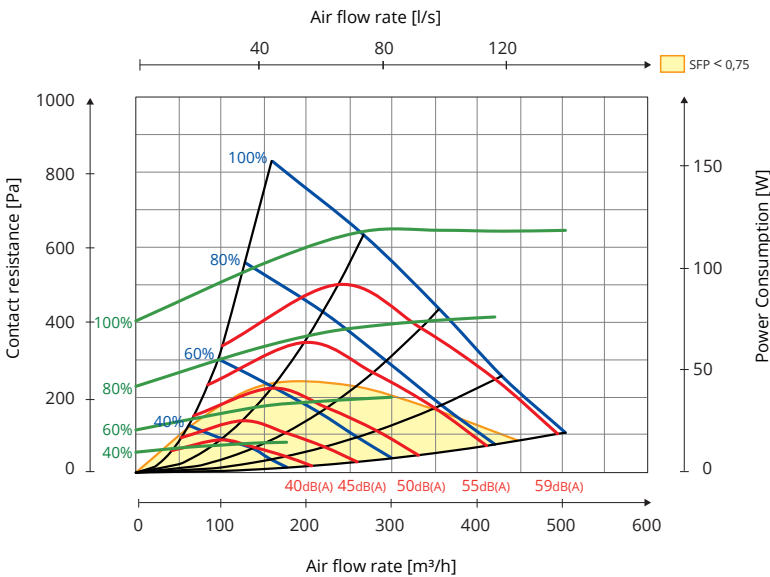

Hz	63 Lw(dB)	125 Lw(dB)	250 Lw(dB)	500 Lw(dB)	1000 Lw(dB)	2000 Lw(dB)	4000 Lw(dB)	8000 Lw(dB)	LwA (dBA)
Supply air	3	3	2	-2	-8	-9	-17	-24	
Extract air	7	8	6	-8	-11	-15	-25	-27	
Radiated	-9	-14	-19	-28	-33	-30	-34	-37	-22

Explanation of diagram:

Sound data is specified as sound power level LwA in the capacity diagrams. (This is sound to duct.)

These values can be corrected by means of the table for the different octave bands in order to look at Lw (without adaptation to A band).

The correction table for the various octaves is stated in Lw, which means that the Lw values are after conversion of each octave for supply air and extract air.

Radiated sound from the unit must be calculated from the supply air diagram.

Position

The unit can be installed in the following ways:

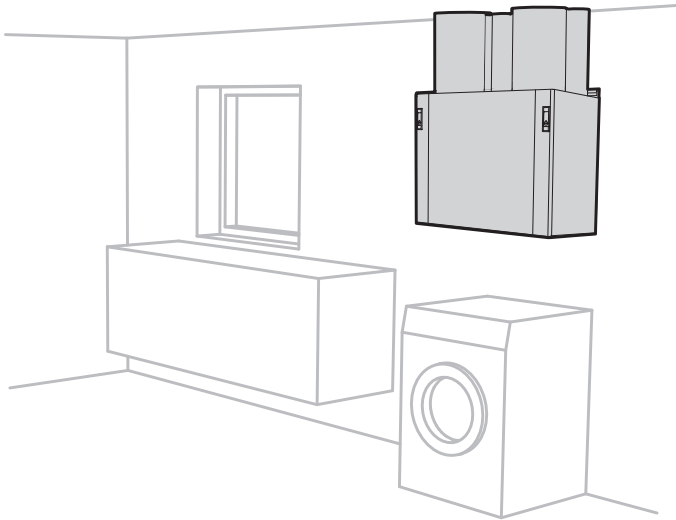

- On a wall
(Mounting supplied with unit.)

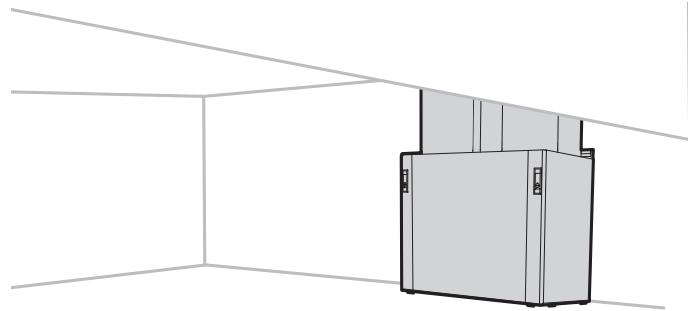

- On the floor
Absorption feet must be fitted
(available as an accessory).

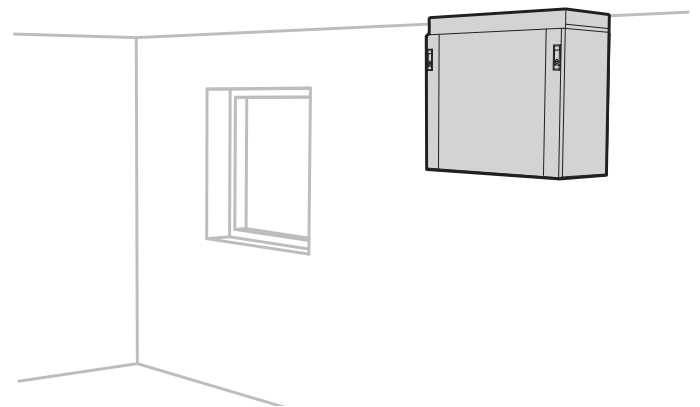

- Suspended from the ceiling
A ceiling mounting must be fitted
(available as an accessory).

Nipple location

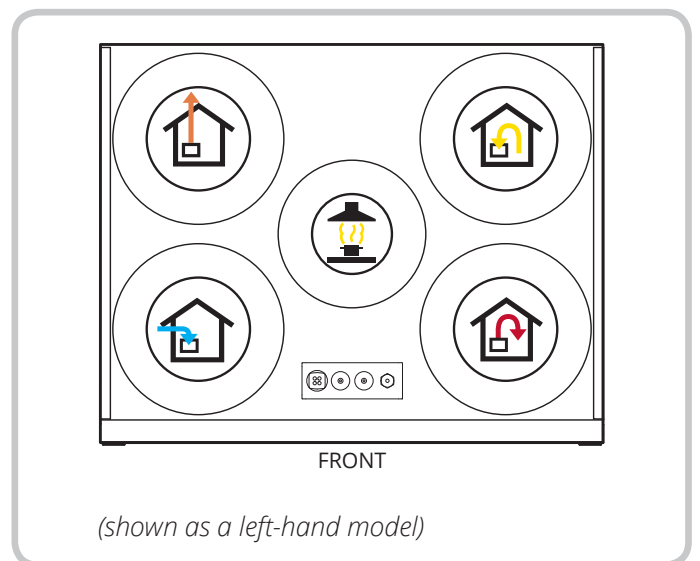
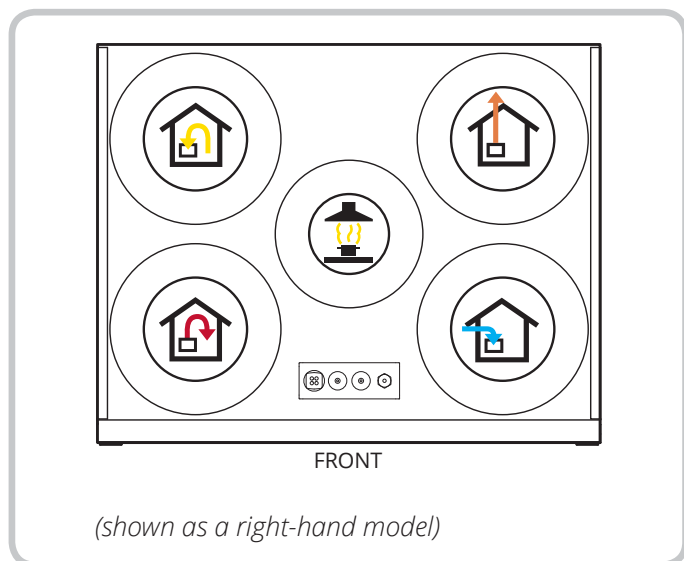

For more information on topics including installation, wiring diagrams and accessories, see www.flexit.com

